

Bachelor Lab Course

IoT Sensor Nodes

Michael Gerndt, Isaac Nunez
Technische Universität München

IoT Components

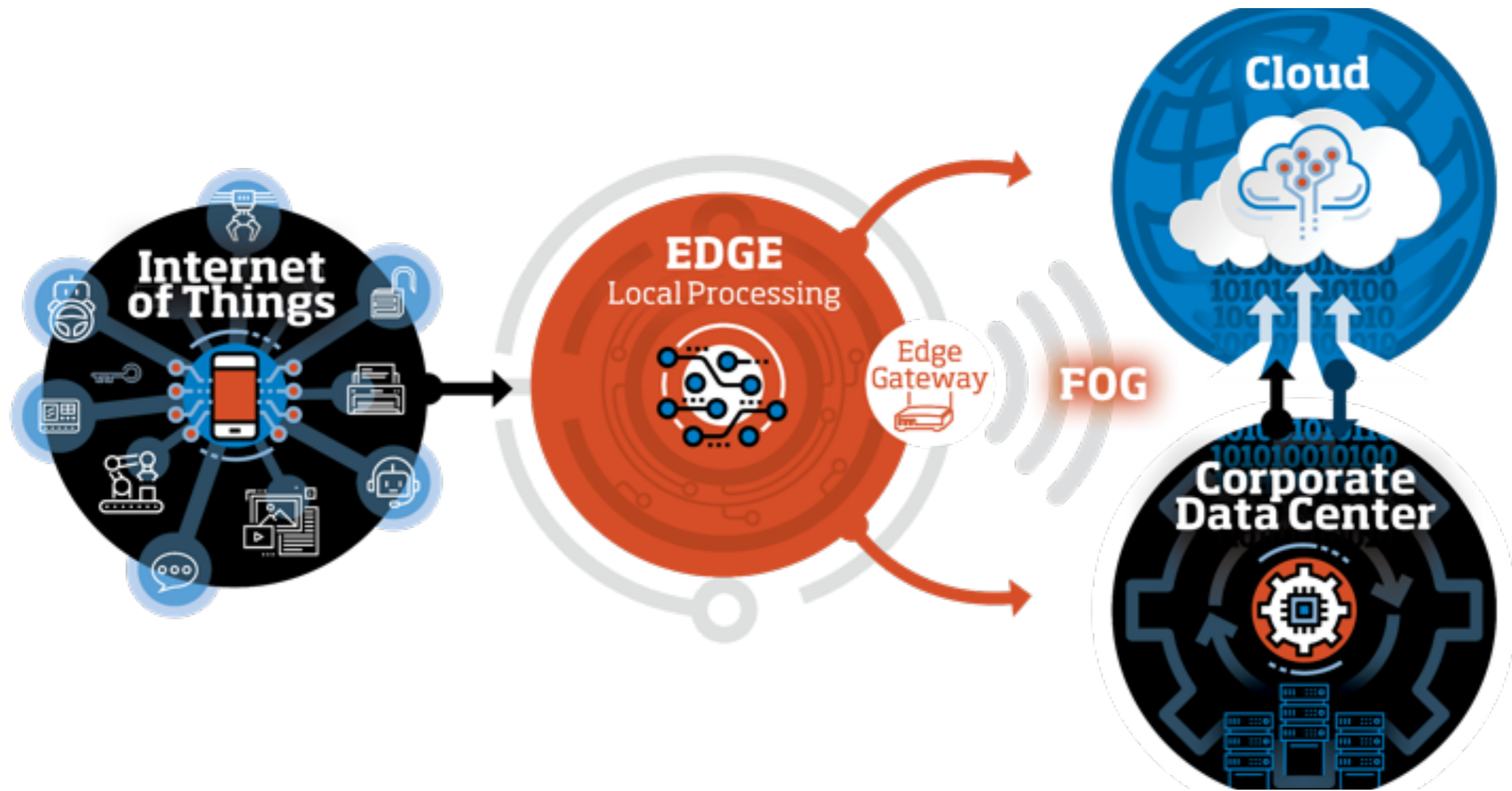

What to expect?

- You have the opportunity to develop the skills for embedded programming!
- The lab provides you with the environment to experiment around sensors and the challenges of resource constraints!
- We also explore the other side of sensing: the requirements to store, process, visualize, and act on incoming data!
- You will also develop the necessary skills to work in teams across a diverse set of skills!

First steps...

- μ Processor vs μ Controller?
- μ Processor
 - Has external memory
 - Only arithmetic and logic functionality
 - It scales to more applications. Multiple μ Processors in a IC.
- μ Controller
 - Memory is integrated
 - It has Flash and SRAM
 - More registers
 - I/O interfaces are also available
 - It is contained in a single IC.
 - Usually found in embedded applications
- Then SoC? SoP?
- Nowadays, terms are more continuous than clear separations...

**What we will be
using?**

Espressif ESP32

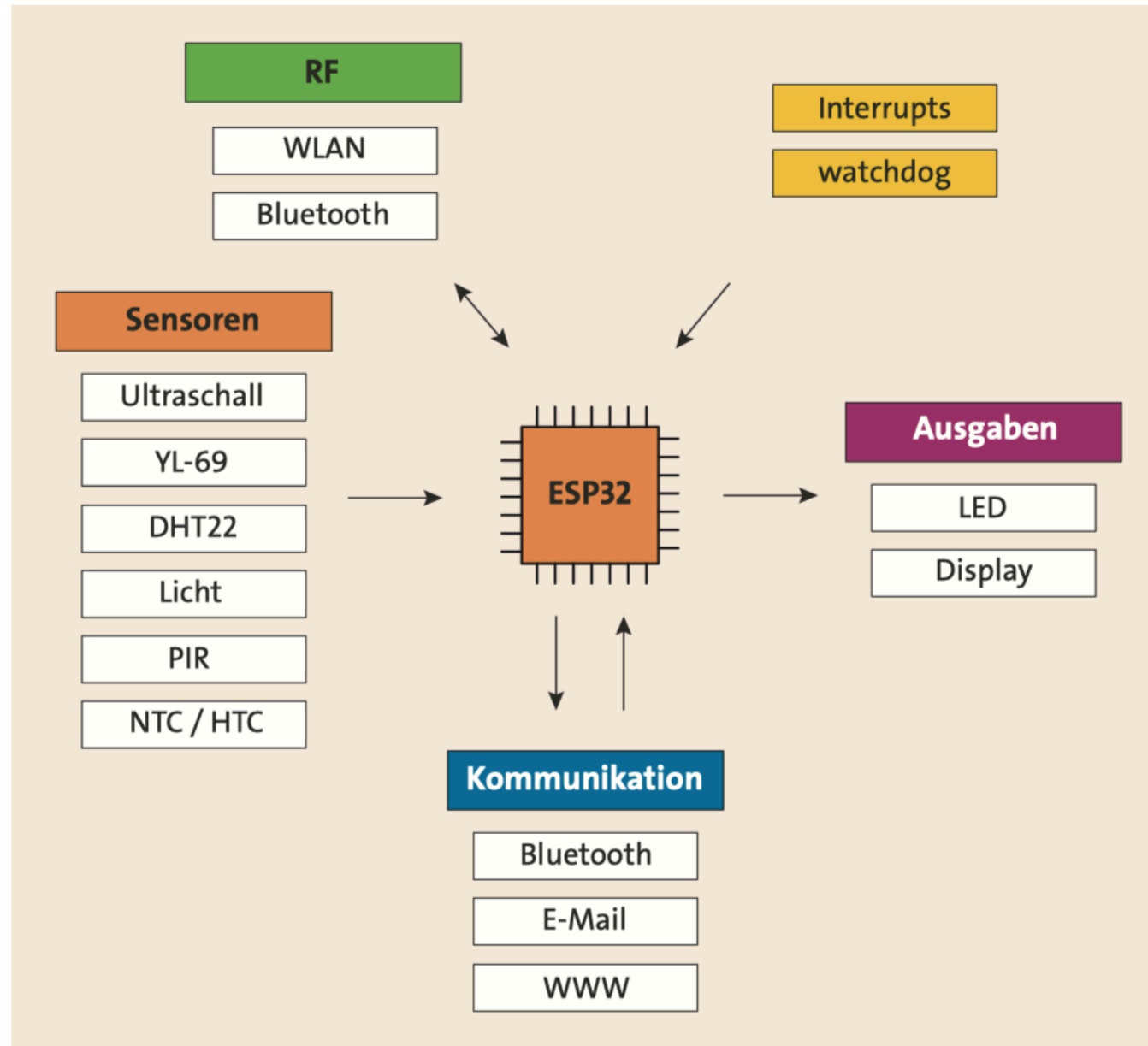

<https://www.espressif.com/en/products/socs/esp32>

ESP32 Block Diagram

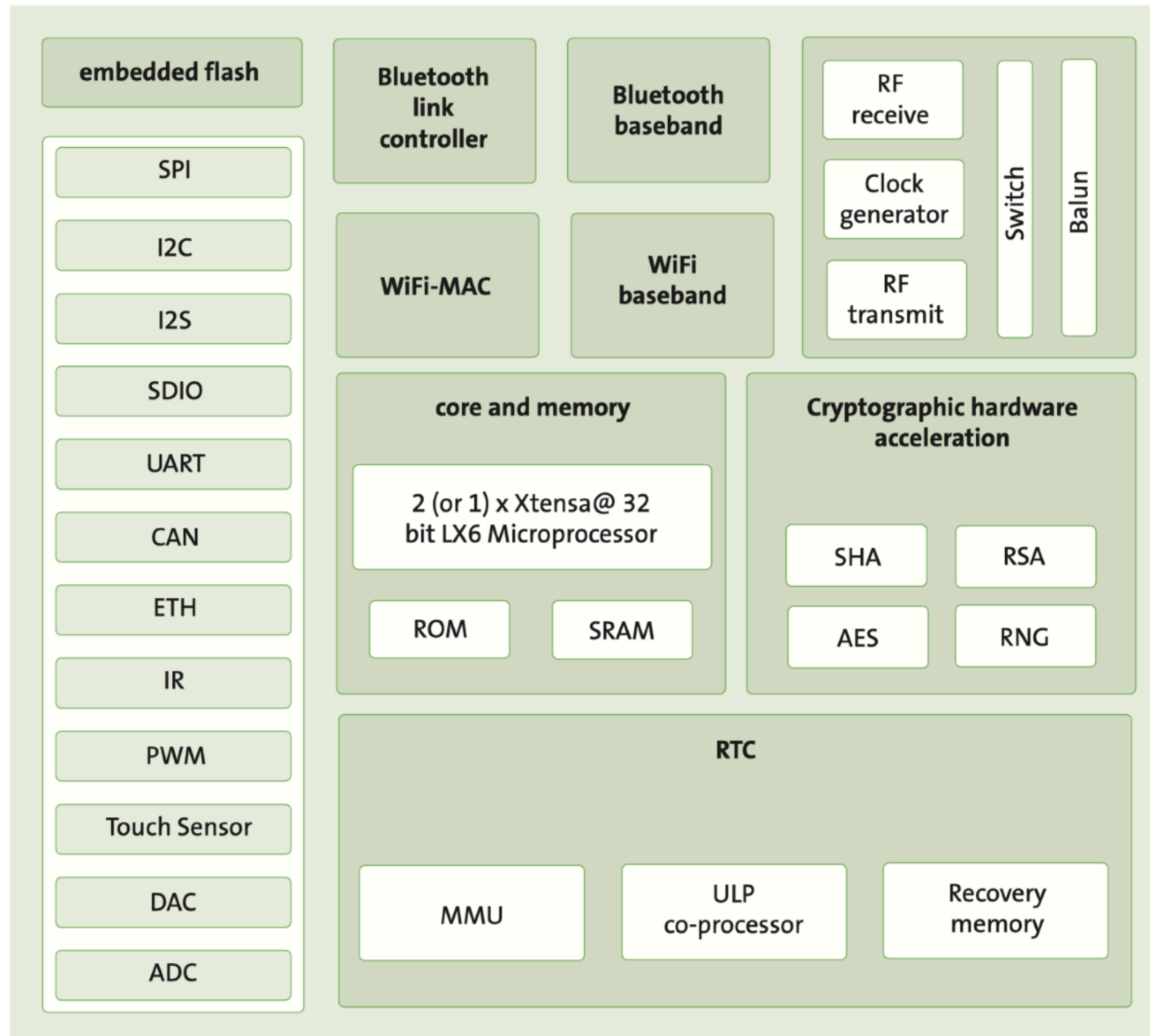

EZSBC ESP32 WROOM

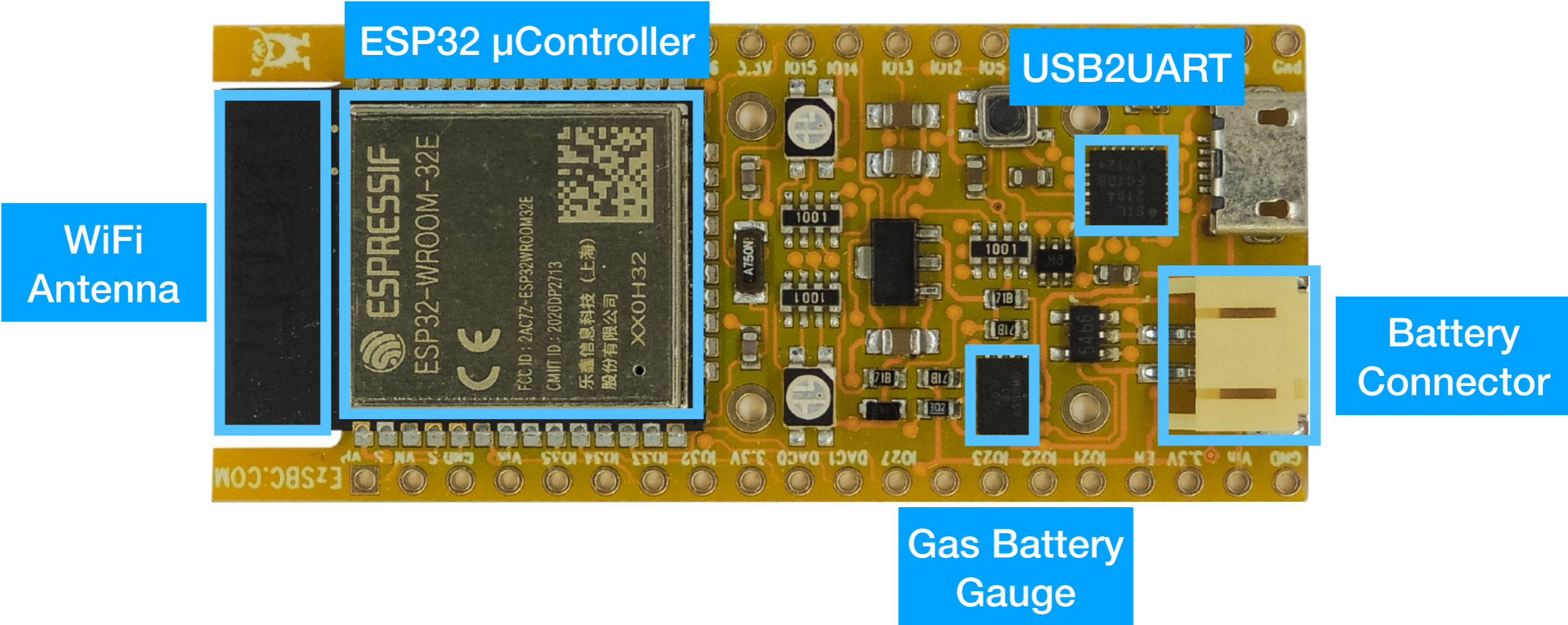

Sensors

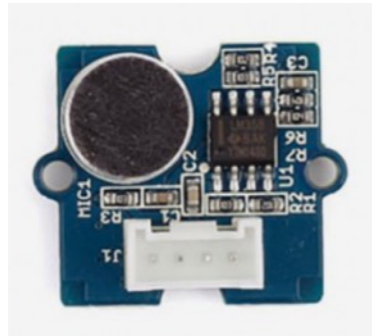

Sound Sensor

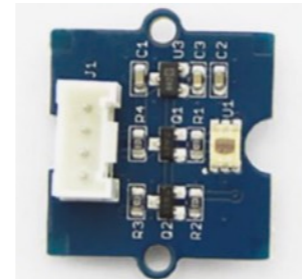

Light Sensor

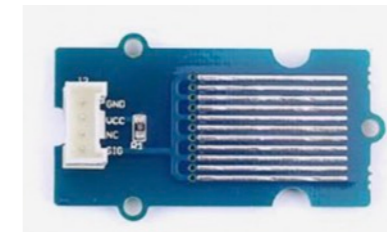

Water Sensor



Soil Moisture Sensor



Ultrasonic sensor

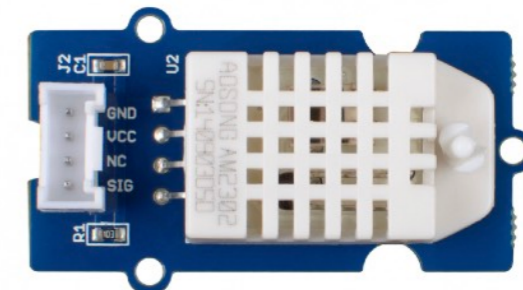

Temperature and Humidity Sensor



Relay

FreeRTOS

- ESP IDF is based on the Free Real Time Operating System (FreeRTOS)
 - freertos.org
 - Maintenance taken over by Amazon from Real Time Engineers Ltd.
 - Integration of sensors with the Greengrass edge runtime
 - It is free: No need to publish your code if developed with FreeRTOS, no fees
- Basically a runtime system linked to the application
- Managing resources: CPU, memory, timers, IO
- Supports soft and hard realtime requirements

Your final project!

- Sense data around Fraueninsel for max. two days.
- You must showcase your data and its meaning using our IoT Platform!
- We want:
 - Count people
 - Collect environment data



Organization

- Part 1 (~6 weeks): Basics of ESP32 and freeRTOS
 - Weekly meetings
 - Mondays between 12:00 and 14:00
 - By solving weekly assignments, you will develop the skills to work with the ESP32, FreeRTOS, and sensors!
- Part 2 (~6 weeks):
 - Teamwork to develop one functionality. More details during the semester!
 - The end of this phase is marked by going to Fraueninsel
 - Your functionality will be part of one (or many) sensor node(s)
 - Your sensor will have to collect data for a few hours
 - **Participating in the trip to Fraueninsel is required to pass the Praktikum!**
- Language:
 - Default: English.
 - TAs and I can also assist in German, although it is not required to participate.

Suggested Pre-requisites

- Lecture and Lab Introduction to Computer Architecture
- C/C++ programming skills
- Experience with Arduino would be helpful but is not required
- Basic knowledge about voltage, current, resistors, ...

- **You don't need to know all of them!** We can also teach you the fundamentals!

Learning Outcomes

- You will
 - understand features and programming of microcontrollers.
 - be able to manage and profit from multicore architectures.
 - know the concepts of real time operating systems.
 - have the required skills to design energy efficient IoT solutions.